



***RST INSTRUMENTS* LTD.**

LP100
Potentiometer
Readout
Instruction Manual

RST Instruments Ltd.
11545 Kingston St
Maple Ridge, BC Canada V2X 0Z5
Tel: (604) 540-1100
Fax: (604) 540-1005
e-mail: info@rstinstruments.com

LP100 Potentiometer Readout

Although all efforts have been made to ensure the accuracy and completeness of the information contained in this document, RST Instruments reserves the right to change the information at any time and assumes no liability for its accuracy.

Product: LP100 Potentiometer Readout

Document number: ELM0061B LP100 Potentiometer Readout Instruction Manual.doc

Revision: B

Date: March 5, 2013

Table of Contents

1	OVERVIEW	1
1.1	Connections of linear potentiometers	2
2	QUICK START INSTRUCTIONS	3
3	POWERING ON/OFF	4
4	LP100 FRONT PANEL CONTROLS	6
4.1	Startup.....	6
4.2	Setting the Date & Time	6
5	MONITOR SETTINGS.....	8
6	MANUAL READINGS	9
7	STORING READINGS IN MEMORY	9
7.1	Creating Memory Locations in the Field	9
7.2	Zero Readout	11
7.3	Store Readings	12
8	REVIEWING DATA	13
9	DATALOGGING	13
10	DELETING.....	14
11	LP100 INTERNAL BATTERY	15
12	SOFTWARE & FIRMWARE UPDATES.....	16
13	WARRANTY	16
14	CONTACT US.....	17
15	APPENDIX A – LP100 MENU FLOW CHART	18
16	APPENDIX C – SPECIFICATIONS	19

Table of Figures

Figure 1 – LP100 Readout.....	1
Figure 2 – Wiring Connections.....	2
Figure 3 – LP100 Meter Electrical Diagram.....	3
Figure 4 – Manual Power Off.....	4
Figure 5 – Auto Off Screen.....	4
Figure 6 – Auto Power Off Time.....	4
Figure 7 – Auto Backlight Off.....	5
Figure 8 – LP100 Readout Details.....	6
Figure 9 – Readings Screen.....	6
Figure 10 – Set Time.....	7
Figure 11 – Date/Time Set.....	7
Figure 12 – Monitor Settings.....	8
Figure 13 – Monitor Settings Options.....	8
Figure 14 – Monitor Settings Options.....	8
Figure 15 – Memory Screen.....	9
Figure 16 – Create Location.....	10
Figure 17 – New Location.....	10
Figure 18 – Zero Readout.....	11
Figure 19 – Zero Readout – select location.....	11
Figure 20 – Zero Readout – accept reading.....	11
Figure 21 – Select Location.....	12
Figure 22 – Storing a Reading.....	12
Figure 23 – Select a Location.....	13
Figure 24 – Reviewing Data.....	13
Figure 25 – Delete.....	14
Figure 26 – Delete Options.....	14
Figure 27 – Battery Door.....	15
Figure 28 – Battery Voltage.....	15
Figure 29 – LP100 Menu Flow-Chart.....	18

1 OVERVIEW

The RST LP100 Readout Instrument is a dedicated intelligent measuring system specially designed for reading, displaying, and logging linear potentiometers. Unprecedented accuracy, flexible memory options and ease of use make the LP100 Potentiometer Readout invaluable for projects requiring monitoring of linear potentiometers. It's lightweight, yet extremely rugged design is perfectly suited for harsh environmental conditions often encountered in the field. Furthermore the LP100 is extremely easy to use with a USB interface for downloading data. Complementing its high level of accuracy, the LP100 is also designed for maximum efficiency with the user in mind. In addition to the simple power requirements of only 3 "AA" batteries, the LP100 comes well-equipped with standard features such as a large graphics display with backlight. Standard AA alkaline batteries are field replaceable, negating the need to return the readout to the factory for battery replacement. The use of standard AA batteries eliminates the need for a charger.

The LP100 is a precision instrument and should be treated as such. It should be protected against shock and heavy vibration. Its case is water resistant; however care should be taken to avoid getting the open unit wet, as damage to internal components could occur.

For any repair, the unit should be returned to the manufacturer as there are no user serviceable parts. In the event that the unit is disassembled by the user the warranty will be void.



Figure 1 – LP100 Readout

- | | |
|--------------------------------|--|
| 1. USB Connector | 5. Scroll Up |
| 2. Large Character LCD display | 6. Scroll Down |
| 3. Backlight | 7. Enter |
| 4. ESC (navigates back a menu) | 8. Terminal Posts
(for sensor connection) |

1.1 Connections of linear potentiometers

All connections are made by simply connecting all wires to the matching color binding post.. The readout automatically detects the instrument and wiring, and displays according to instrument.

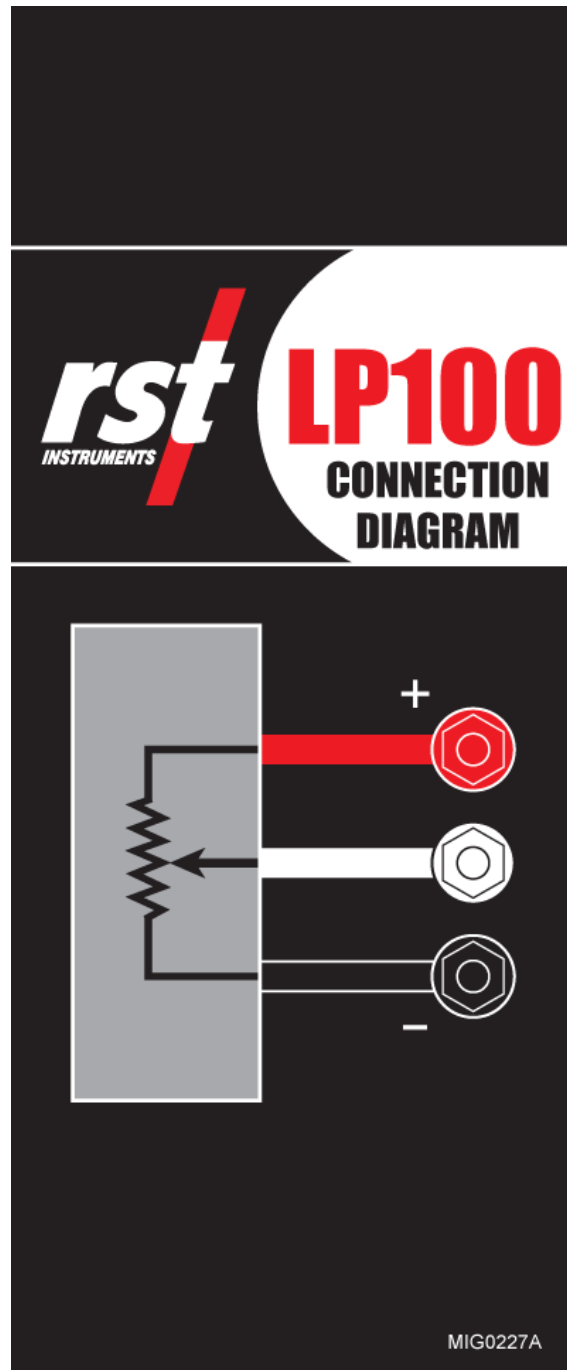

Figure 2 – Wiring Connections

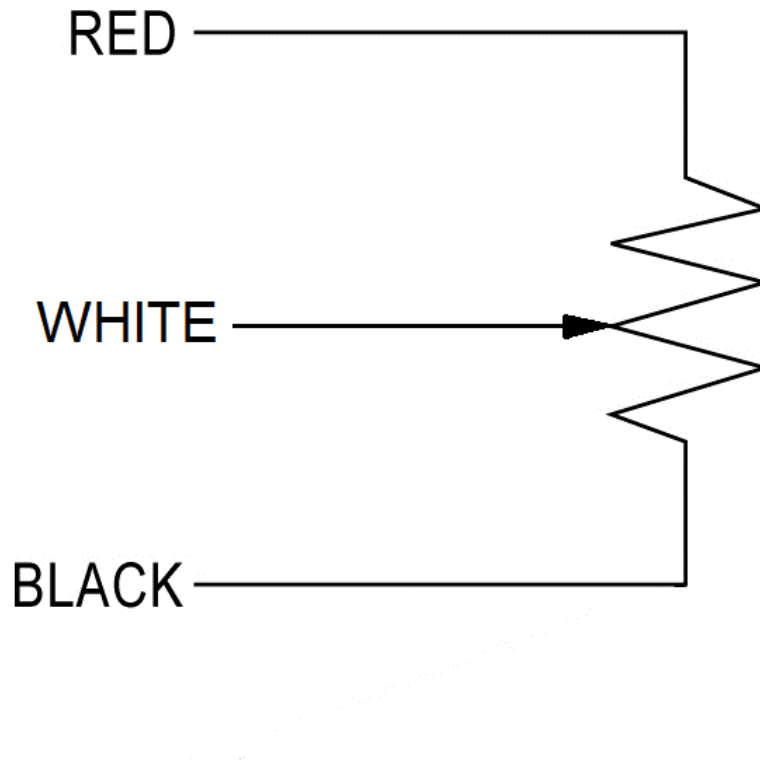

Figure 3 – LP100 Meter Electrical Diagram

2 QUICK START INSTRUCTIONS

The instructions for performing a manual reading on a linear potentiometer (i.e. not storing to memory) are simple and straightforward:

1. Connect the Piezometer to the terminal block (Figure 1)
2. Turn display on (press any key)
3. Wait a few moments for unit to startup
4. Record the displayed reading (%).

Note

Step 4 (above) is assuming the Monitor Settings are set to *default*. The LP100 has the ability to custom configure the readout settings so that engineering units can be displayed. Please refer to the Multireadout Host Software Instruction Manual for more information.

3 POWERING ON/OFF

The LP100 readout can be powered on anytime by pressing any key. The unit can be powered off manually or automatically. To power off manually, use the up/down arrows to scroll to the following screen:

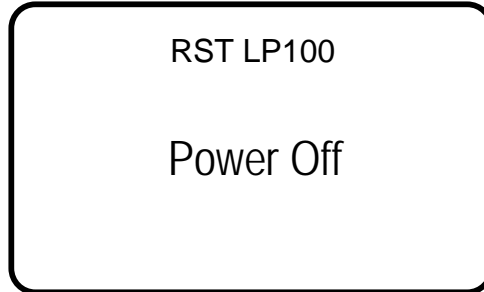

Figure 4 – Manual Power Off

- Press *Enter* and the unit will turn off.
- To adjust the automatic power off settings, navigate to the *Auto Off* screen as shown below:

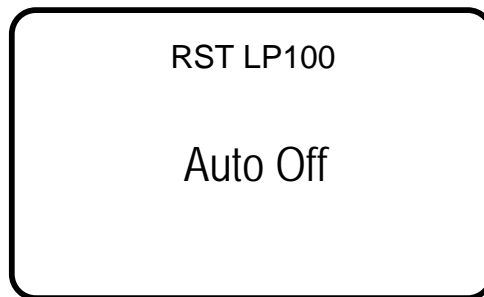

Figure 5 – Auto Off Screen

- Press *Enter* and the following screen will appear:

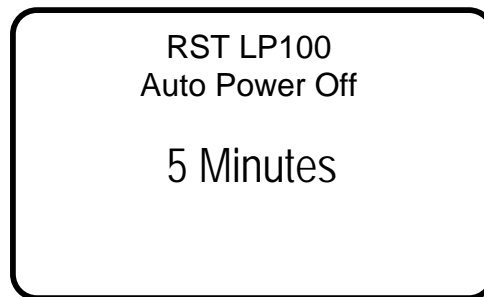

Figure 6 – Auto Power Off Time

Use the arrow keys to scroll to the desired auto power off time. Please note that the auto power off feature is always active and cannot be disabled. This is to conserve battery life. The default is 5 minutes. The next screen prompts to set the Auto Backlight Off:

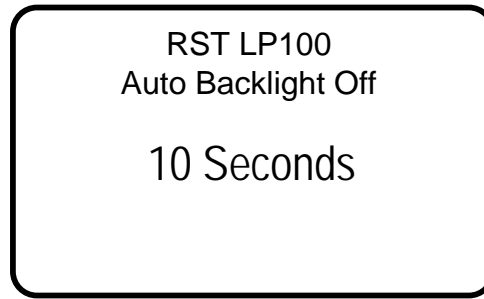

Figure 7 – Auto Backlight Off

Use the up/down scroll buttons to adjust.

4 LP100 FRONT PANEL CONTROLS

4.1 Startup

Upon powering on the unit (by pressing any key), an opening screen will appear showing the RST Instruments logo. If the user wishes to view the details of the readout *press any key* immediately and the following will appear:



Figure 8 – LP100 Readout Details

This displays the model, version number, serial number and the current date/time settings. It is always a good idea to ensure that the date and time are correct, as this may affect any readings being stored in memory on the unit. Refer to section 4.2 for setting the date and time.

Upon connecting of the linear potentiometer, readings will display as shown below.

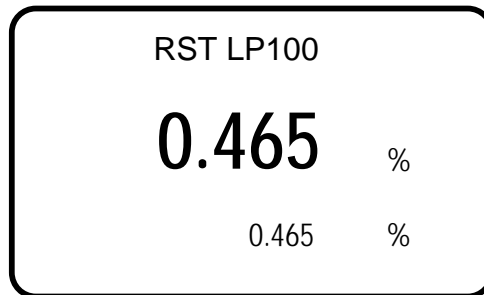

Figure 9 – Readings Screen

The readings screen displays the current strain reading and converted value (assuming an instrument is connected).

4.2 Setting the Date & Time

Keeping the date and time current ensures that you have accurate historical records of your data. Whenever a reading is taken and stored in the units' memory, an associated date/time stamp is always included.

- Turn on the readout by pressing any key.
- Using the arrow keys, scroll down to the *Set Time* screen and press *Enter*:



Figure 10 – Set Time

- The current editable data field will have an underline, use the arrow keys to modify the field and press enter when complete (pressing enter cycles through each field).

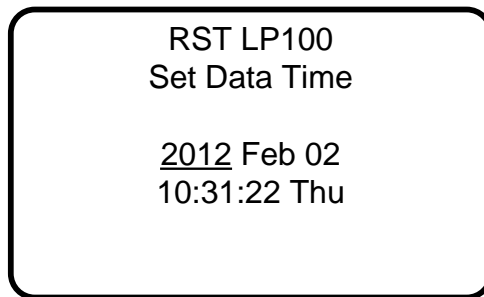

Figure 11 – Date/Time Set

- When complete the program will exit to the main menu screen.

5 MONITOR SETTINGS

Various parameters of the LP100 readout can be adjusted by selecting the *Monitor Settings* menu as shown below:

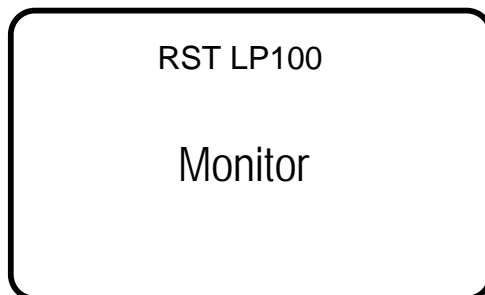

Figure 12 – Monitor Settings

Press *Enter* to choose whether a custom or predefined setting is required.

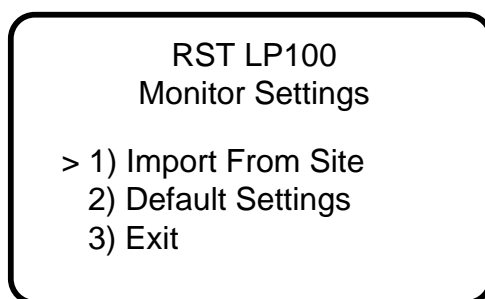

Figure 13 – Monitor Settings Options

- Select *Import From Site* to copy settings from existing location.
- To reset settings to default, select *Default Settings*. Monitor readings will have no zero reading and mV/V units.
- Select *Exit* to go back to previous menu.

The sample monitor screen is shown below.

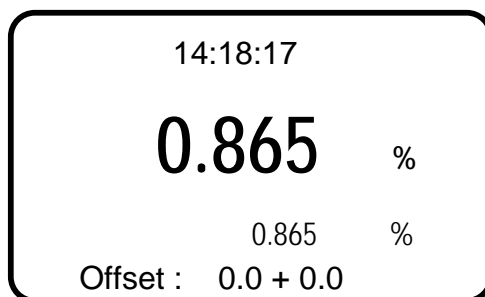

Figure 14 – Monitor Settings Options

The peak reading can be shown by pressing the backlight button for about 3 seconds. To reset or turn off peak reading, press backlight switch again for about 3 seconds.

6 MANUAL READINGS

The following instructions outline the basic steps needed to take a manual reading with the LP100 readout:

- Connect the instrument leads to the quick-connect terminals. Match the wires color for color.
- Turn on the readout by pressing any key.
- The readout will go through its startup procedure, and automatically default to the reading screen.
- The mV/V reading will appear along with the engineering units converted value.
- Record the reading and move onto the next instrument.

For memory functions, please refer to section 7.

7 STORING READINGS IN MEMORY

The LP100 has 128k of internal memory allowing it to store over 11 000 time-stamped, readings. The current memory usage is displayed on *Memory* screen, as shown in Figure 15. Data can be reviewed either on-board or downloaded to a host computer via the USB connector. Individual locations can be preconfigured in the office via the Multireadout Host Software or by creating locations on the unit itself (section 7.1).

7.1 Creating Memory Locations in the Field

The LP100 Readout has the ability to be either pre-configured in the office (through Host Software), or taken directly to the field. If taken directly to the field, each location will be assigned a generic name which is editable once back in the office and connected to a host computer. In most cases it is recommended that the LP100 be pre-configured in the office prior to taking readings in the field. In this manner, site location names can be setup ahead of time allowing the field personnel to be able to arrive at instrument locations, and store readings without needing to create a location in the units' memory.

If the LP100 has not been pre-configured in the office, the following instructions explain how to create new locations. Please refer to Figure 29 (flow chart) for a graphical representation of the steps outlined below:

- Turn on the readout by pressing any key.
- Using the arrow keys, scroll to *Memory* and press *Enter*.

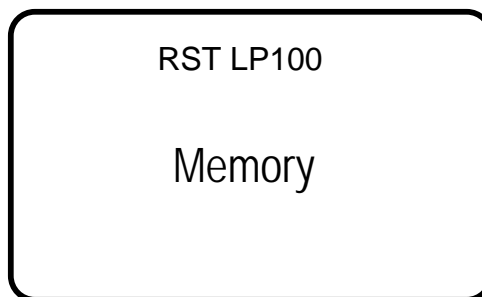

Figure 15 – Memory Screen

- Press *Enter* to advance to the next screen.

- Using the arrow keys, scroll to *Create Location* and press *Enter*.

Note
The maximum number of predefined locations is 254.

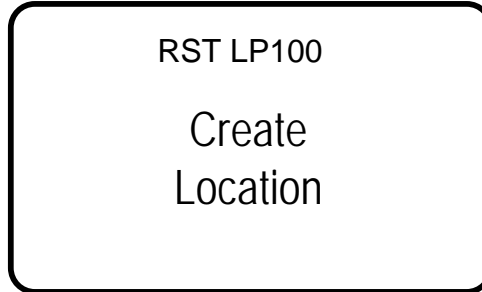

Figure 16 – Create Location

- The readout unit will automatically create a site called *Location X* where 'X' is the next storage location available in the units' memory. Please note that when creating new sites in the field, you can only name them *Location X*. Make note of the real location name in your field notebook and its relation to the *Location* number. When connecting to the Host Software back in the office, a custom name can be entered at that time. This replaces the site name assigned by the readout.

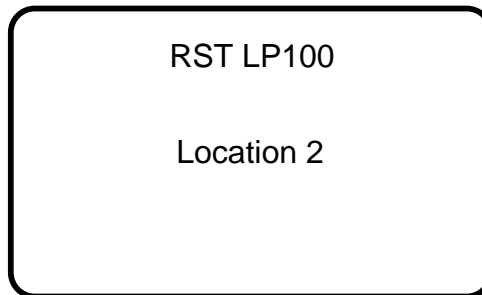

Figure 17 – New Location

- The LP100 automatically increments the new location to the next number available.
- Press *Enter* and the unit will return to the previous menu.

Note
Engineering units calibration can only be set using the Multireadout Host Software, please refer to the Host Software manual for further information.

7.2 Zero Readout

For each created location, zero reading needs to be recorded. Connect to appropriate sensor, and then use the arrow keys to scroll to *Zero Readout* and press *Enter*. The following screen will appear:

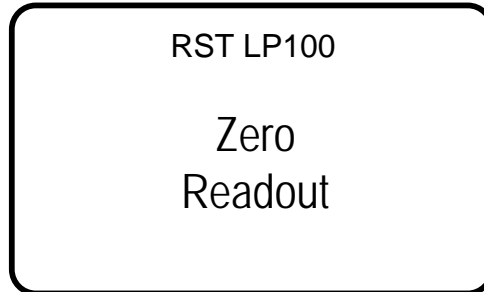

Figure 18 – Zero Readout

- Use the arrow keys to select location. When the desired location is found, press *Enter* to select it. The following will appear:

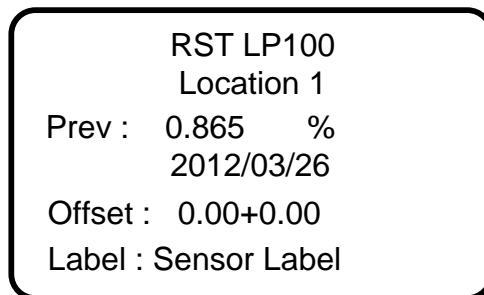

Figure 19 – Zero Readout – select location

- The LP100 will prompt you with the question: *Accept?*, press *Enter* to store the reading.

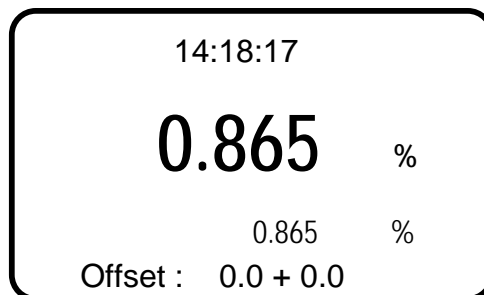

Figure 20 – Zero Readout – accept reading

- After storing the reading, the LP100 will return the user to the previous screen.

7.3 Store Readings

- Use the arrow keys to scroll to *Store Data* and press *Enter*. The following screen will appear:

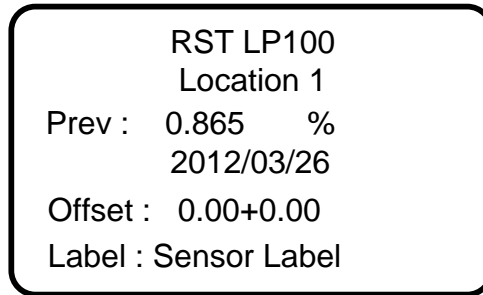

Figure 21 – Select Location

- Use the arrow keys to select location. When the desired location is found, press *Enter* to select it. The following will appear:

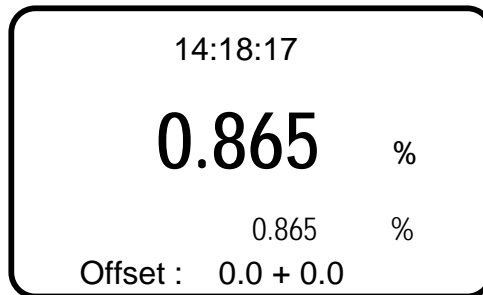

Figure 22 – Storing a Reading

- Reading time and zero value are displayed for a reference.
- The LP100 will prompt you with the question: *Accept?*, press *Enter* to store the reading.
- After storing the reading, the LP100 will return the user to the previous screen.

8 REVIEWING DATA

To review any reading on the LP100 unit itself, please follow these instructions:

- Power on the readout by pressing any key.
- Using the arrow keys, scroll down to *Memory*, press *Enter*.
- Scroll to *Review Data* and press *Enter*.
- Scroll to the desired location (using arrow keys). If the previous reading session was downloaded using Host Software, the *Prev* value shows last reading in previous session. Refer to Multireadout Host Software manual for instructions. If present, zero reading for currently selected location is displayed along with recording date.
- Press *Enter* to display recorded data.

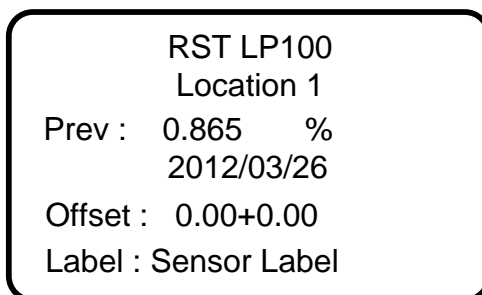

Figure 23 – Select a Location

- If the location contains more than one reading, these readings can be scrolled through using the arrow keys. The date and time of each reading will appear to differentiate each reading.

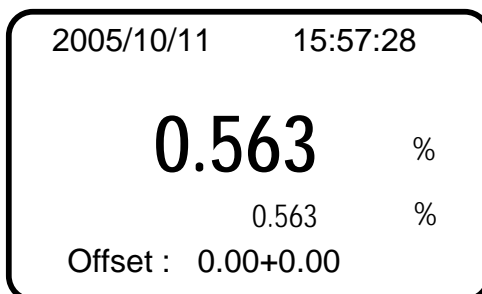

Figure 24 – Reviewing Data

9 DATALOGGING

The LP100 will have basic datalogging function in next readout revision. The user will be able to set the datalogging interval and the number of iterations.

Note

Datalogging will be available in next firmware version..

10 DELETING

All location information can be deleted from the LP100 readout or via the host Software. This is done by the following:

- Power on the display by pressing any key.
- Using the arrow keys, scroll down to *Memory*, press *Enter*.
- Using the arrow keys, scroll to *Delete* and press *Enter*.

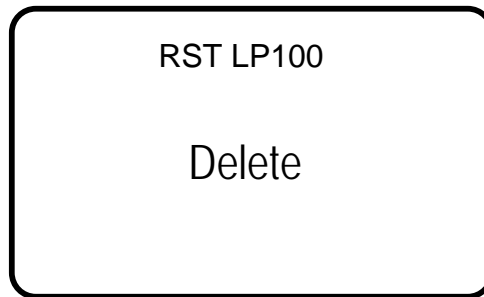

Figure 25 – Delete

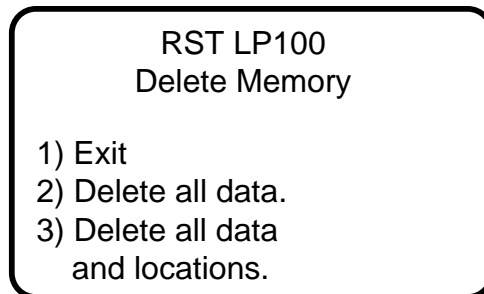

Figure 26 – Delete Options

- Using the *arrow keys*, scroll to the desired delete option and press the *Enter* key to select. Press *Enter* to confirm, press *ESC* to exit back to the main menu.

11 LP100 INTERNAL BATTERY

The RST LP100 operates on 3 alkaline AA batteries. Access to the batteries is done through a port on the side of the unit. Use a flathead screwdriver or a coin to access the batteries (see Figure 27). The unit ships standard with regular AA batteries. If the unit is being used consistently in cold environments, the user may replace the alkaline batteries with lithium batteries which are also readily available.



Figure 27 – Battery Door

The status of the battery can be checked by:

- Turning on the readout by pressing any key.
- Using the arrow keys, scroll to the battery voltage screen.
- The readout will display the *battery voltage* as shown below:



Figure 28 – Battery Voltage

Note

If the battery voltage drops below 3.5 volts a low battery warning will be displayed in the form of "BATT" in the upper right of each screen. Change the batteries at this time.

12 SOFTWARE & FIRMWARE UPDATES

The LP100 readout is designed such that the unit's software and firmware can be easily updated by the customer through the USB port. Please regularly visit: <http://www.rstinstruments.com> for product updates.

13 WARRANTY

RST Instruments Ltd. reserves the right to change the price or modify the specifications of its equipment without notice.

RST Instruments Ltd. agrees, for a period of 12 (twelve) months from the date of purchase, as evidenced by the date of the invoice, to replace any equipment which fails or malfunctions as a result of defects in materials or workmanship when that equipment has been serviced or installed by the servants or agents of RST Instruments Ltd. The agreement to replace herein contained does not apply to the compensation or any portion of installation or site preparation

There is no warranty, representation, or condition of any kind, expressed or implied with respect to the equipment or the accuracy or longevity thereof, except that of replacement as stated above. RST Instruments and its servants or agents will not be liable for any special, indirect or consequential damages arising from the servicing or installation of the equipment, nor shall recovery of any kind against the said company be greater in amount than the purchase price of the specific equipment purchased which allegedly caused the damage. The purchasers assumes all risks and liabilities for any loss, damage or injury to persons or property of the purchasers or others, however caused, arising out of the use or possession of any equipment supplied by RST Instruments Ltd. save and except the agreement to replace contained herein.

14 CONTACT US

For sales information contact: sales@rstinstruments.com

For technical support contact: rst_support@rstinstruments.com

Head Office:

11545 Kingston St
Maple Ridge, BC
Canada V2X 0Z5

Our office hours are: 8:30am – 5:00pm PST
Monday – Friday (excluding holidays)

Telephone: 604-540-1100

Facsimile: 604-540-1005

Toll Free: 1-800-665-5599

Website: <http://www.rstinstruments.com>

15 APPENDIX A – LP100 MENU FLOW CHART

The following flow chart outlines all functions of the LP100 front panel controls:

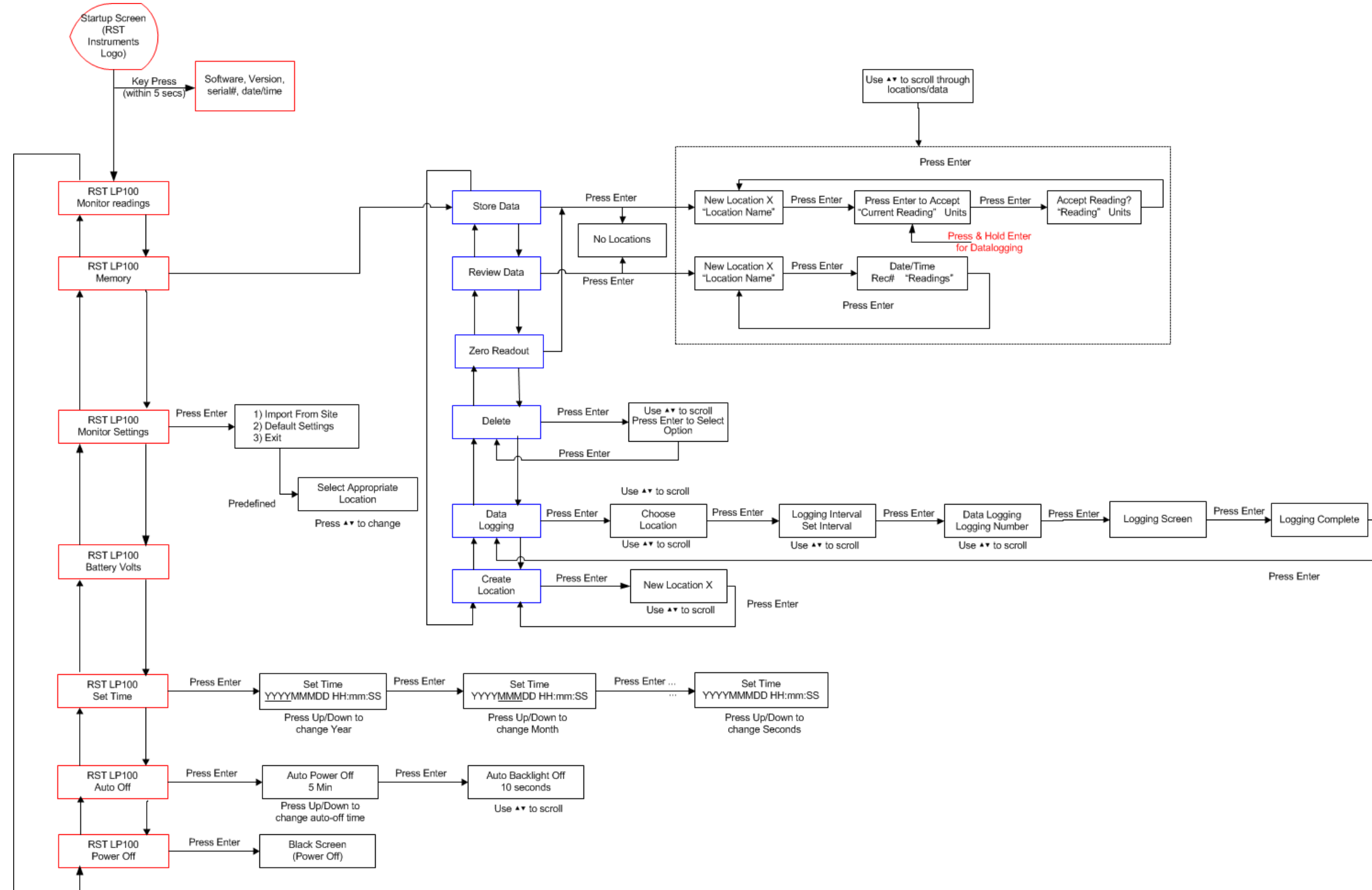

Figure 29 – LP100 Menu Flow-Chart

16 APPENDIX C – SPECIFICATIONS

<i>Description</i>	<i>Specification</i>
Display	Graphic 128 x 64 pixels large character display
Display Backlight	High efficiency LCD with auto off
Memory	128 kB
Max Instrument Locations	254
Memory Capacity	11400 custom labeled points
Location Identification String	Up to 20 characters
Download Speed	15 seconds (full memory)
Battery	3 "AA" alkaline
Battery Indicator	On-screen low battery indicator
Operating Temperature	-20 °C to 60 °C
Dimensions	W 22cm x D 19cm x H9.5cm (8.75 x 7.5 x 3.75in.)
Weight	1.1 kg (2.4 lbs)